

Advancing Pediatric Cancer Research and Drug Development Through Multistakeholder Collaboration

A Framework Based on the Tovorafenib Journey

◆ **Authors**

Annette Bakker, PhD
Caitlyn Barrett, PhD
Upal Basu Roy, MPH, PhD
John Hopper
Marc Hurlbert, PhD
Christa Kerkorian
Mark Kieran, MD, PhD
Donna Ludwinski
Amy Weinstein

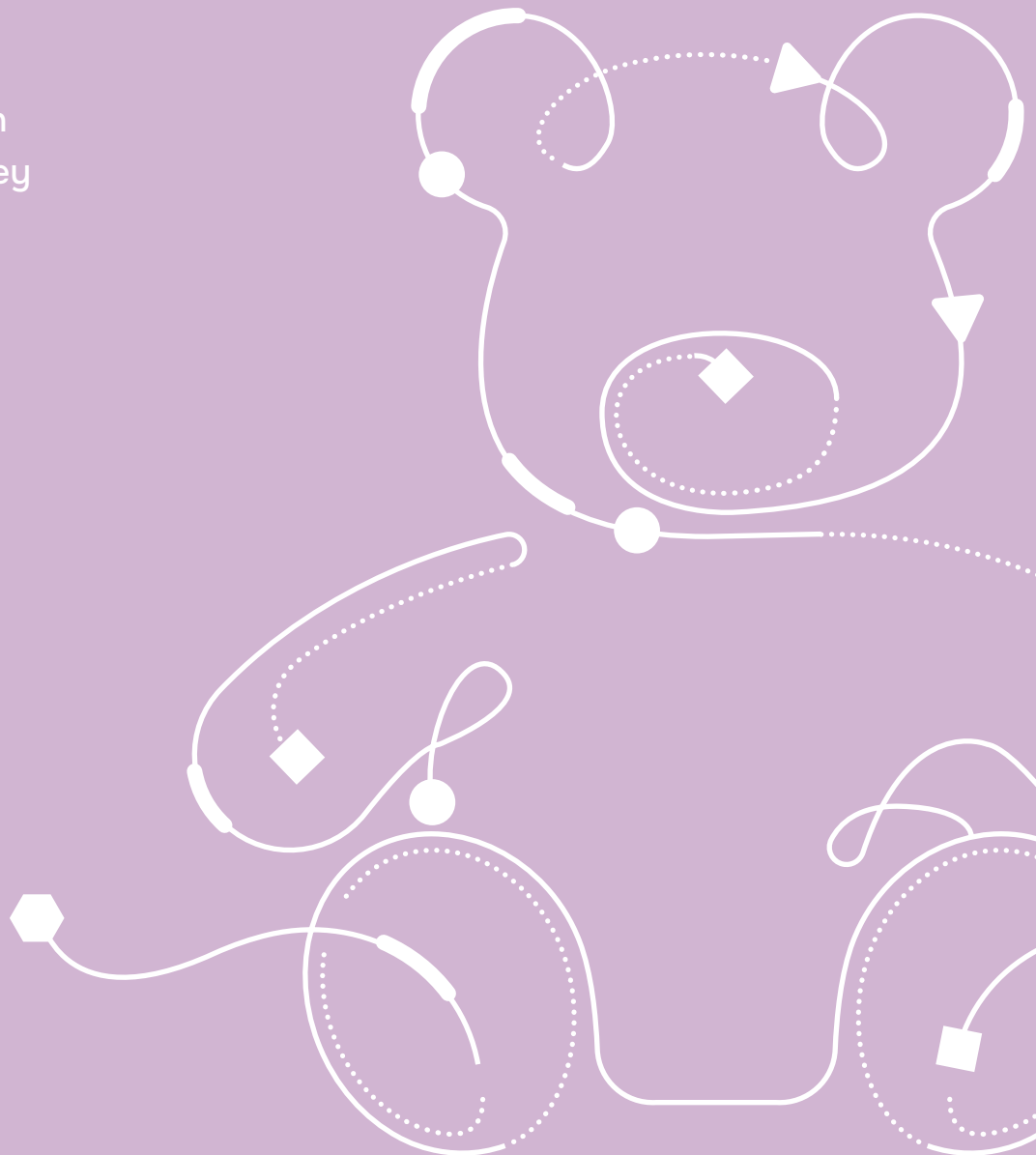



AUTHORS

Annette Bakker, PhD

Children's Tumor Foundation

Caitlyn Barrett, PhD

Milken Institute

Upal Basu Roy, MPH, PhD

LUNGevity Foundation

John Hopper

National Organization for Rare Disorders, Rare Cancer Coalition

Marc Hurlbert, PhD

Melanoma Research Alliance

Christa Kerkorian

Day One Biopharmaceuticals

Mark Kieran, MD, PhD

Day One Biopharmaceuticals

Donna Ludwinski

Solving Kids' Cancer

Amy Weinstein

Pediatric Brain Tumor Foundation

CONTRIBUTORS

Heidi Adams

Rx4Good

Gary Nolan

Colab Health

REVIEWERS

E. Anders Kolb, MD

Leukemia & Lymphoma Society

Joe McDonough

The Andrew McDonough B+ (Be Positive) Foundation

Kirk Tanner, PhD

National Brain Tumor Society

Contents

Foreword	04
Executive Summary	06
Introduction	08
The Tovorafenib Journey to Date	12
Learning From the Tovorafenib Journey	14
Framework for Multistakeholder Collaboration	16
Conclusions	28
Appendix	29
References	30

Foreword

As a pharmaceutical industry patient advocate, I have always believed that collaboration with patients, families, and the non-profit organizations (NPOs) that represent them is critical to advancing research and drug development. In pediatric cancer, a research landscape where challenges are numerous and progress has been slow, this is especially true. A testament to the power of collaboration is the remarkable journey of tovorafenib, a drug that, if not for the actions of a small group of families facing their own children's cancer diagnoses, may never have been discovered as a potential treatment for pediatric low-grade glioma (pLGG).

Upon joining Day One in 2021, I began learning about the long and winding road of the tovorafenib journey and the collaboration among NPOs, academia, and industry that have made it possible thus far. The more I learned about this real-life story, the more I believed that there were lessons to be learned and applied more broadly.

To that end, in January 2023, Day One Patient Advocacy convened a workshop with experienced leaders from NPOs, as well as academia and industry, to explore the tovorafenib journey to date. With support from workshop co-chairs Caitlyn Barrett, PhD (Milken Institute), and Donna Ludwinski (Solving Kids' Cancer), the workshop focused on the people, processes, and partnerships that advanced tovorafenib from its origins as a drug studied only for use in adult cancers to a registrational clinical trial for a pediatric cancer. Although primarily based on the input and perspectives of the NPOs, the result of the workshop is a much broader picture of how three stakeholder groups—NPOs, academia, and industry—can work together to advance research and potential new therapies for pediatric cancer.

This white paper brings this picture into focus through a Framework for Multistakeholder Collaboration in Pediatric Cancer Research and Drug Development (Framework). The Framework, which was developed prior to the United States (US) Food and Drug Administration's accelerated approval of tovorafenib, introduces critical components of collaboration and explores the unique roles and responsibilities of each stakeholder group. The Framework and insights that follow are geared primarily to US-based pediatric cancer NPOs that fund academic research. However, these learnings are also applicable to stakeholders in academia and industry and to other non-pediatric cancers and other rare diseases.

By sharing the Framework, we hope to prompt further discussions and greater collaboration to advance pediatric cancer research and drug development. It is one step in the right direction. We look forward to building upon our learnings, evolving the Framework, and working together to change the outlook for children with cancer and their families.

On behalf of Day One and the co-authors of this paper, we hope that these insights will prove beneficial to you in your efforts, as well.

Sincerely,

CHRISTA KERKORIAN

Vice President, Patient Advocacy
Day One Biopharmaceuticals

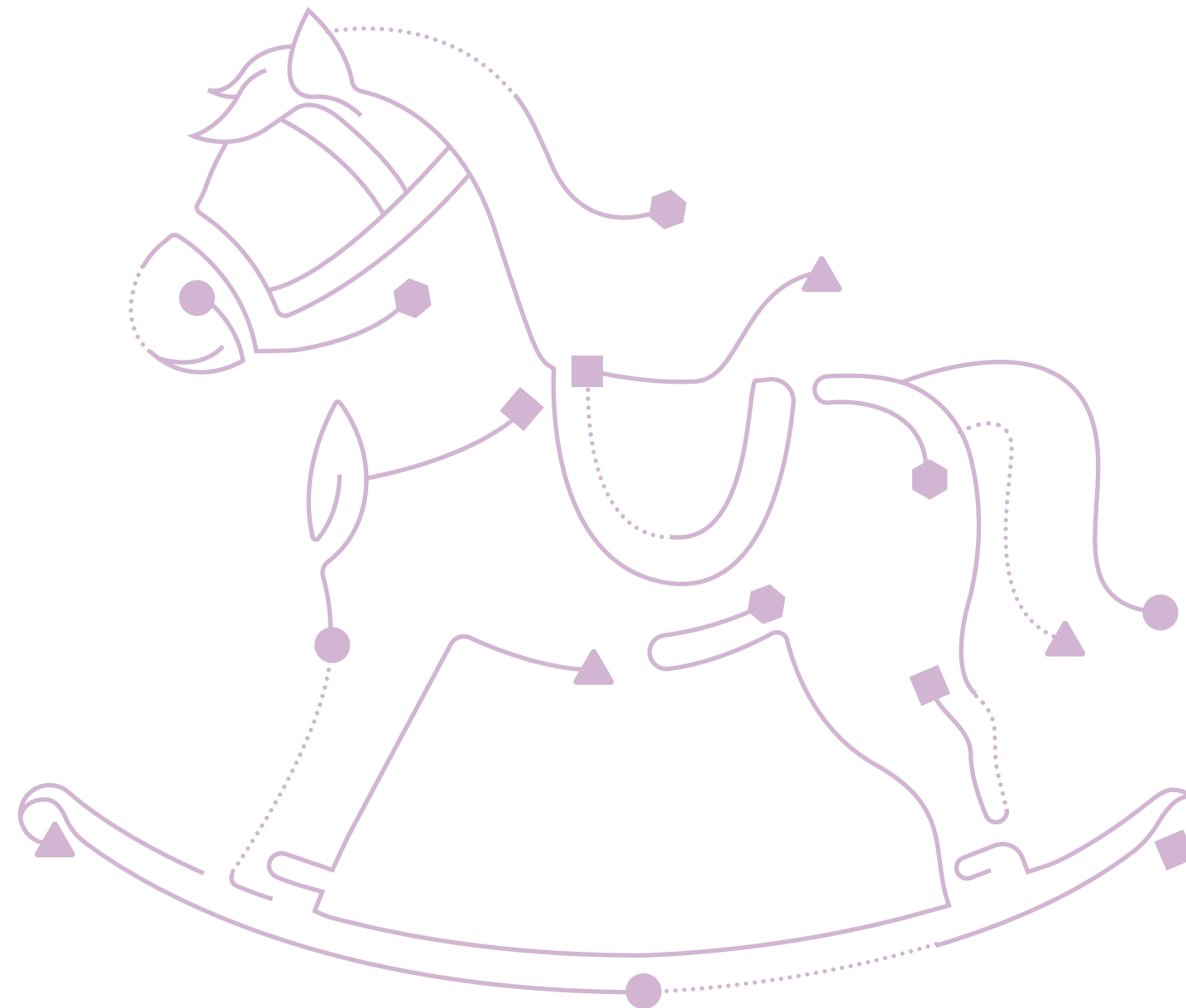

Executive Summary



Pediatric cancer research and drug development have advanced slowly over the past several decades, with new treatments developed for and available to children with cancer lagging far behind those for adults with cancer.

When patients, parents, and families facing a childhood cancer diagnosis are confronted with this reality, they are often and understandably shocked and deeply frustrated by the lack of available treatment options for their children.

Many barriers and challenges across the research and drug development ecosystem have contributed to this historical lack of progress; notably, the limited financial incentives for pharmaceutical companies (industry) to invest in and commercialize new therapies, and the misalignment of objectives between industry and the academic researchers (academia) who drive much of our scientific understanding of these diseases and clinical testing of new drugs. In many instances, parents and families determined to overcome these obstacles become powerful advocates for change by establishing non-profit organizations (NPOs) to raise awareness and fund pediatric cancer research. Ultimately, bringing new therapies to children with cancer requires collaboration between key stakeholders—NPOs, academia, and industry—working closely with the health authorities that establish and administer regulatory requirements and incentives for pediatric cancer research and drug development. In recent years, collaborations among these stakeholders have proven to be effective vehicles to advance pediatric cancer research.

One such example of high-impact collaboration is reflected in the journey of tovorafenib, which began in 2005 when a determined group of parents sought to address the lack of treatments for pediatric low-grade astrocytoma (PLGA). They formed the PLGA Foundation (PLGAF) to fund PLGA research and, in collaboration with Dana-Farber Cancer Institute (DFCI) and other family foundations, supported work that led to the identification of preclinical activity of tovorafenib (previously known as MLN2480, TAK-580, and DAY101) in pediatric low-grade glioma (pLGG). This discovery led to a registrational clinical trial in relapsed or progressive pLGG sponsored by Day One Biopharmaceuticals (Day One). On April 23, 2024, Day One announced the United States (US) Food and Drug Administration's (FDA) accelerated approval of tovorafenib.

Based on the premise that certain aspects of the tovorafenib journey could serve as a model to support advancement of other pediatric cancer research, Day One's Patient Advocacy team sought to explore the journey in more detail. With a focus on the people, processes, and partnerships that have made the tovorafenib journey to date possible, on January 27, 2023, Day One convened a workshop focused on exploring the dynamics of collaboration between three US-based stakeholder groups: NPOs, academia, and industry. The workshop was structured to identify and define key elements of this collaboration and associated roles and responsibilities of each stakeholder group. Leaders representing each stakeholder group participated in the workshop, and their collective contributions resulted in the development of a Framework for Multistakeholder Collaboration in Pediatric Cancer Research and Drug Development (Framework), highlighting the key characteristics, roles, and responsibilities of effective collaboration.

The learnings presented in this paper, although grounded in pediatric oncology, are also applicable to non-pediatric cancers and other rare diseases facing similar challenges in advancing research and new therapies.

Introduction

THE PEDIATRIC CANCER RESEARCH AND DRUG DEVELOPMENT LANDSCAPE

Despite the fact that cancer is the leading cause of disease-related death for children and adolescents in the United States (US)¹ (see *Figure 1*), drug development for childhood cancers has been remarkably slow when compared with advances of new therapies for adult cancers (see *Figure 2*). Historically, biotech and pharmaceutical companies that have successfully brought new therapies to adult cancer patients have been dissuaded by the challenges of developing new therapies for children with cancer.

FIGURE 1. Estimated number of children and adolescents in US that will be diagnosed with cancer in 2024.

9,620 5,290

Children aged 0–14 years Adolescents aged 15–19 years²

FIGURE 2. FDA approvals for pediatric oncology indications and time taken for progression from adult clinical trials to trials involving children.

From 2012 to 2021, the U.S. Food and Drug Administration (FDA) approved 341 oncology indications.³ Of these, only 39 were for pediatric indications (11.4%).³ Moreover, cancer drugs approved by the FDA typically take approximately 6.5 years to progress from their first clinical trial in adults to the initiation of the first trial involving children.⁴

One of the challenges industry has faced is the rarity of pediatric cancers, which make it difficult to gather an adequate number of patients from specific subpopulations for enrollment in clinical trials capable of generating statistically significant efficacy data. Pediatric cancer drug development may also require investments in additional pediatric toxicology studies.⁵ Additional factors that can compound clinical and manufacturing costs include determining dosage adjustments based on age and weight and differences in formulation and administration routes, to name a few.⁶ Even with relatively streamlined clinical trial recruitment and operations, the complexities and risks coupled with the difficulties in recouping costs and generating value for shareholders are strong deterrents for industry-led pediatric cancer drug development.

While industry-sponsored progress in pediatric cancer drug development has been minimal, the academic research community has significantly advanced scientific understanding of pediatric cancers through investigator-sponsored basic and translational research and clinical trials. Nevertheless, these studies are generally undertaken with the goal of publication and to support ongoing research grant applications, rather than with the intention to file new drug approvals by regulatory authorities. While new initiatives (e.g., fit-for-purpose studies)⁷ are being discussed that would make early pediatric clinical trial data more compatible with regulatory requirements, the cost of such trials are often significantly higher than standard academic-led clinical trials and thus are beyond what most academic programs can support.

IMPACT ON PATIENTS AND FAMILIES

Due to limited progress in drug development for children and adolescents with cancer, many parents and families discover that the treatment options available for children today are identical to those offered to adults over 30 years ago.⁸ For many malignancies, cytotoxic chemotherapy is a primary component of multi-modality treatment, despite its severe side effects. For survivors, late effects following treatment include chemotherapy-induced cardiotoxicity, peripheral neuropathy, or secondary tumor risk from radiation and many chemotherapy agents.⁹ Also, many survivors are susceptible to developing reproductive disorders, such as primary ovarian failure and male germ cell dysfunction, significantly impacting their fertility.¹⁰ Despite the decrease in childhood cancer mortality rates, with over 85% of those diagnosed now surviving for more than five years, 95% of survivors will face at least one significant health-related issue by age 45.^{10,11} Furthermore, even long after treatment has ended, childhood cancer survivors may still grapple with health challenges that affect their overall well-being, including physical, mental, and social aspects of their lives.¹²

The entire family is profoundly impacted by a child's cancer diagnosis and treatment, with parents experiencing significant psychosocial and emotional distress.¹³ Siblings face their own emotional and psychological challenges, which can impact them for the rest of their lives.^{14,15} Adding to these challenges, the financial burden of caring for a child with cancer can be substantial; expenses, such as medication costs, travel for treatment, childcare, and lost income from needing to take leave from work, further compound the emotional and physical toll on the entire family.^{16,17} In such situations, parents and caregivers are driven to do whatever it takes to provide the best care for their child. For some, this may involve learning everything they can about their child's condition, fully engaging with the medical system, enhancing their knowledge of their child's condition, and/or actively researching and advocating for new treatment options, including investigational therapies.

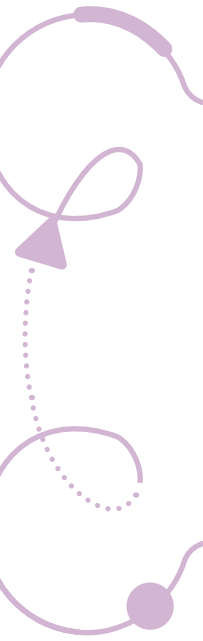

THE POWER OF NON-PROFIT ORGANIZATIONS AND PATIENT ADVOCATES

The passion and persistence of parents and families have driven some of the most significant progress in changing the pediatric cancer drug development landscape. In the US, many of the childhood cancer non-profit organizations (NPOs) leading change and funding research have been established by bereaved parents in honor of their children or by parents of childhood cancer survivors.^{18,19} They actively inform policy, provide support and education to families, fund research, and raise awareness of unmet needs for specific pediatric cancers and for childhood cancer more broadly.

Public policy has been impacted significantly by the work of NPOs and the families they represent. Recent federal legislation changes in the US that are directly attributable to efforts of NPOs include: the Pediatric Research Equity Act,²⁰ the Research to Accelerate Cures and Equity for Children Act,²¹ the Best Pharmaceuticals for Children Act (BPCA),²² and the Rare Pediatric Disease Priority Review Voucher Program²³ (see *Figure 3*). These legislative initiatives have resulted in increased investments in pediatric cancer research by federal agencies and industry.

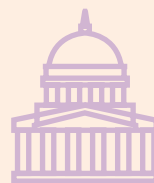

FIGURE 3: Examples of legislation or programs to encourage pharmaceutical investment in pediatric cancer drug development.

Pediatric Research Equity Act (PREA)

This Act empowered the US Food and Drug Administration (FDA) with the authority to require drug manufacturers to conduct studies in children for the same adult indications when it is expected that the drugs will be used in a substantial number of children.²⁰

Best Pharmaceuticals for Children Act (BPCA)

The BPCA encourages pharmaceutical companies to conduct pediatric clinical studies by providing an additional 6 months of patent exclusivity. It also authorizes the National Institutes of Health (NIH) to prioritize certain therapeutic areas and sponsor off-patent drugs for further study in children.²²

Research to Accelerate Cures and Equity (RACE) for Children Act

This Act amended the PREA and authorized the FDA to require pediatric clinical trials for new oncology drugs that may target pediatric cancer growth or progression.²¹

Rare Pediatric Disease Priority Review Voucher Program (PRV)

Under PRV, a sponsor who receives an approval for a drug or biologic for a "rare pediatric disease" may qualify for a voucher that can be redeemed to receive a priority review of a subsequent marketing application for a different product.²³

However, legislation alone is not the answer, as thus far, very few recent drug approvals are attributable to the aforementioned initiatives.³ To date, some of the most significant progress in pediatric cancer research has been achieved when NPOs, academia, and industry have collaborated to advance scientific discoveries in pediatric cancer. Some notable initiatives that emphasize multistakeholder collaboration include ACCELERATE, the Children's Tumor Foundation, and the Leukemia & Lymphoma Society's PedAL Master Clinical Trial (see *Figure 4*).

In recent years, some NPOs have adopted new approaches to support promising research, increasing their influence in advancing research and drug development. Often bolstered by leaders and staff who come to these organizations with direct professional experience in academia and/or industry, these NPOs take on more active roles in driving the research they support. This may include funding translational drug development, acting as project managers to facilitate research progress, offering physical space and expertise for researchers to spin out their work into new companies, providing funds for preclinical experiments through Contract Research Organizations (CROs) or acting as a discounted-rate CRO themselves.³⁰

Some NPOs engage in traditional in-house research and development, covering activities from discovery to Phase II clinical trials, excluding Phase III due to financial constraints. In the venture philanthropy model, NPOs may also provide financial support to for-profit companies—both young and established biotech companies—for translational development projects or new programs within their research and development arms. Such support is often provided in exchange for equity, or another vehicle for financial return.

Ultimately, whether an NPO chooses a more traditional research funding mechanism or adopts one of these newer, innovative models, all NPOs play an important role in bringing the patient and family perspective to the process, working with academia and industry to help bridge the gaps between unmet medical needs and the research required to bring patients closer to potential treatments or cures.

FIGURE 4: Notable examples of effective multistakeholder collaborations. ACCELERATE is an international multistakeholder collaborative platform that brings together academia, industry, NPOs and regulators (both European and US) to speed development of innovative therapies for children and adolescents with cancer.

◆ **ACCELERATE Working Groups**, composed of representatives of key stakeholder groups, explore and propose solutions for specific pediatric oncology challenges. Current Working Group efforts include: fostering age-inclusive research, developing an international registry for long-term follow-up, and developing best principles for designing and delivering an academic trial with a dataset that can be included in regulatory filing packages that meet global regulatory requirements.²⁴

◆ **ACCELERATE Pediatric Strategy Forums** are multistakeholder meetings held in partnership with the European Medicines Agency (EMA) and with the participation of the FDA. The Forums focus on either a specific malignancy or class of compounds (based on mechanism of action) to facilitate prioritization and increase feasibility of drug development. At the Forums, academic experts present the landscape, regulators actively participate (without providing advice or making regulatory decisions), patient advocates speak to unmet needs, and pharmaceutical companies present available data. The 11 Forums held since 2017 have successfully led to global master protocols and provided information for regulatory discussions and product prioritization by Industry.²⁵

Children's Tumor Foundation (CTF) launched a multistakeholder, interdisciplinary Synodos research model in 2014 to share previously unpublished data in neurofibromatosis (NF) to accelerate the translation of trial outcomes for a wider clinical benefit. The Synodos NF2 initiative (\$3 million/3 years) has led to the discovery of assets that are currently in clinical development in the Takeda-CTF co-funded NF2 platform trial.²⁶ The NF preclinical initiative teams have completed 116 preclinical trials in eight years, leading to multiple clinical trials, including the MEK inhibitor selumetinib registrational trial.²⁷ These studies displayed the power of pooled resources guided by multispecialty advisors of academia, industry and NPOs.

The CTF is currently upscaling their preclinical services in a preclinical hub and will, thanks to the funding of the European Innovative Medicine Initiative (EUPEARL), be able to implement the NF1/ SWN platform trials in Europe.²⁸

The Leukemia & Lymphoma Society's PedAL Master Clinical Trial is a groundbreaking precision medicine clinical trial in acute pediatric leukemia to test new, safer therapies on children by matching them to treatments based on their unique tumor biology. It is an international collaboration including the National Cancer Institute (NCI), the Children's Oncology Group (COG), the European Pediatric Acute Leukemia (EuPAL) Foundation, AbbVie, and Kura Oncology, and is available to children in North America, Australia, New Zealand, and Europe. Additional NPO funders include the Gateway for Cancer Research and the Lisa Dean Moseley Foundation. As of February 2024, 256 patients had enrolled in a screening trial that serves as a single-entry point to two therapeutic trials, with additional trials in development to study new agents.²⁹

The Tovorafenib Journey to Date

Every effort has been made to accurately reflect the collaborations and partnerships that have supported the journey of tovorafenib to date. Where appropriate, abbreviations and simplifications have been made to the tovorafenib story to remain focused on important milestones and events.

In 2005, a small group of parents with children diagnosed with pediatric low-grade astrocytoma (PLGA), dismayed by the lack of safe and effective treatments, approached Dana-Farber Cancer Institute (DFCI) and several other academic institutions for insights on how they could support the development of new treatment options for all children with PLGA. Investigators at DFCI advised that establishing a dedicated PLGA research program would be essential to uncovering new treatment options. This endeavor would require a focused effort to enhance the understanding of the molecular makeup and biology of the disease. To support such an initiative, they said, the research program would require seven-figure funding on an annual basis, sustained over the long term.

With that in mind, these families provided seed funding to DFCI to kickstart the effort. Soon after that, they established the PLGA Foundation (PLGAF, now the PLGA Fund of the Pediatric Brain Tumor Foundation (PBTF)) to expand their base of support and fundraising capabilities nationwide. In 2007, the PLGAF committed \$5 million over five years, alongside additional significant funding from other foun-

dations and private donors, to support the formation of a dedicated DFCI PLGA program. The PLGAF also sponsored grants and collaborated with several other academic medicine centers of excellence to advance scientific discoveries in PLGA. To guide its research funding decisions, the PLGAF formed an independent scientific advisory board (SAB). Included in the SAB were representatives of the following disciplines: the pharmaceutical industry, neurobiology, pediatric and adult neuro-oncology, neuroscience, cancer biology, molecular neuropathology, general medical oncology, and NPOs. The PLGAF SAB was and continues to be independent of any cancer institution. Today, as part of PBTF, the PLGA Fund continues to support PLGA research at academic institutions worldwide.

At DFCI, supplemented by government-funded grants (e.g., NCI Specialized Programs of Research Excellence (SPORE)),³¹ Dr. Mark Kieran (Director of Pediatric Neuro-Oncology) and Dr. Charles Stiles (Co-Chair, Department of Cancer Biology) initiated a critically important study to understand the underlying biology of pediatric-low grade glioma (pLGG; of which PLGA is a subset) and identify molecular characteristics of the disease (see Figure 5). Based on findings that showed the predominance of RAS/RAF/MAPK alterations in pLGG,³⁹ Drs. Kieran and Stiles worked with a DFCI chemist to synthesize all known compounds that could be used to study and/or treat the disease. Importantly, almost all the compounds were not yet being tested in pediatric cancers.

During the multi-year process of conducting preclinical studies of the synthesized compounds, the DFCI research team identified one compound, MLN2480 (also known as TAK-580, DAY101, and now tovorafenib), as having activity in an array of tumors harboring a KIAA1549-BRAF fusion or the BRAF V600E point mutation, the two most common molecular abnormalities in pLGG.⁴⁰ Following this discovery, the PLGA DFCI clinical and research team approached the owner of the compound, Millennium Pharmaceuticals (Millennium), with the aim of obtaining support to launch a first-in-pediatrics clinical trial evaluating MLN2480 in pLGG. At the time, Millennium was evaluating the drug in a clinical trial for adult cancers.

This 2016 trial proposal, in partnership with the Pacific Pediatric Neuro-Oncology Consortium (PNO), was approved and initiated in 2018.⁴¹ Shortly after initiation of this Phase I clinical study (PNO014), Millennium, which had since been acquired by Takeda Pharmaceuticals (Takeda), made the decision to cease development of MLN2480 (TAK-580) in adults. Development of TAK-580 in pLGG would have been discontinued as well, if not for a team of committed champions for pediatric cancer at Takeda. They convinced Takeda leadership to give TAK-580 new life by out-licensing the drug to a pharmaceutical company interested and qualified to move the program forward.

Around this same time, venture capitalist Ms. Julie Grant and Dr. Samuel C. Blackman, a DFCI-trained pediatric neuro-oncologist who had transitioned to industry many years earlier, co-founded Day One Biopharmaceuticals. The company's mission is to develop new treatments for children with cancer, bringing new hope to them and to their families.⁴² Takeda was familiar with Day One and its co-founders and believed the new company might be interested in acquiring TAK-580. Coincidentally, Dr. Blackman served as an industry representative on the PLGAF SAB that had been reviewing the progress of the DFCI team. When Day One was contacted by Takeda about their decision to discontinue TAK-580, the company was in a unique position to consider acquisition of the drug in earnest.

In December 2019, Day One successfully in-licensed TAK-580 from Takeda and renamed the molecule DAY101 (see Appendix). Less than two years later, Day One initiated a registrational Phase II study (FIREFLY-1) to evaluate DAY101 (tovorafenib) in pediatric and young adult patients with relapsed or refractory, BRAF-altered, pLGG.⁴³ On April 23, 2024, Day One announced the FDA's accelerated approval of tovorafenib.⁴⁴

FIGURE 5: About pediatric low-grade glioma (pLGG).

PLGGs are chronic and may continue growing until patients reach their early 20s, often resulting in profound tumor and treatment-associated morbidity that can impact their life trajectory over the long term.³² Pediatric low-grade gliomas are the most common central nervous system (CNS) tumor in children.³³ Until recently, for most of these slow-growing tumors, there were no approved targeted therapies; the main treatments being surgical resection and chemotherapy. Prognosis for these tumors is good, with 10-year overall survival rates of 85-96%.^{34,35,36} However, survivors are at higher risk of suffering profound side effects from both the tumor and the treatment, which may include chemotherapy and radiation.³⁷ Despite this, pLGGs remain understudied and underfunded relative to adult low-grade gliomas and relative to other rare but more aggressive pediatric brain tumors.³⁸

The historical lack of progress in the treatment of pLGG is multifactorial, including i) concerns by pharmaceutical companies that inclusion of pediatric patients into clinical trials could damage the approval process in their adult indications if any significant adverse events occurred; ii) lack of a sense of urgency in academia, often related to the overall good survival of pLGG patients, especially when compared to most adult and other pediatric cancers; iii) for reasons not fully elucidated yet, once pediatric patients enter their 20s, most pLGGs stop growing spontaneously and never grow again; and iv) the difficulty academic investigators interested in this area have getting grants and publications, mostly related to issues ii and iii above.

Learning From the Tovorafenib Journey

On January 27, 2023, Day One hosted a US-focused, multistakeholder workshop to explore and learn from the tovorafenib journey.⁴²

The specific workshop objectives were to:

- ◆ Identify the critical components that have made possible the tovorafenib journey to date
- ◆ Prioritize the critical components and highlight their key characteristics
- ◆ Define the associated roles and responsibilities of three stakeholder groups: NPOs, academia, and industry

With a focus on multistakeholder collaboration and best practices, Day One sought to better understand the people, partnerships, and processes that contributed to tovorafenib's advance toward a registrational clinical trial for a pediatric cancer and apply those learnings to future initiatives.

The workshop brought together a group of patient leaders selected for their experience advancing and funding pediatric cancer research, advocating for policy change, and/or facilitating collaboration within the research community. The group also included leaders from NPOs focused primarily on adult cancers to share relevant lessons learned from rare adult cancer research. A significant strength of the workshop was the wide-ranging professional expertise of the participants, whose backgrounds also included extensive experience in academia and industry (see Figure 6).

The workshop was co-chaired by Christa Kerkorian from Day One, Caitlyn Barrett from the Milken Institute, and Donna Ludwinski from Solving Kids' Cancer.^{42,45,46} Gary Nolan of Colab Health facilitated the workshop as moderator.⁴⁷ Day One offered transportation and lodging for participants, as appropriate, and offered all participants reasonable compensation for their time and expertise.

The workshop commenced with a presentation to familiarize the participants with the tovorafenib story, with emphasis on pivotal relationships and partnerships, rather than on scientific and medical aspects of the drug. Following this foundation-setting presentation, participants moved into breakout sessions to identify the critical components of the tovorafenib journey and the associated roles and responsibilities of NPOs, academia, and industry.

FIGURE 6: Workshop participants.

Annette Bakker, PhD — President
Children's Tumor Foundation, Chair of CTF Europe

Caitlyn Barrett, PhD — Associate Director
Milken Institute Center for Strategic Philanthropy

Elly Barry, MD, MMSc — Chief Medical Officer
Day One Biopharmaceuticals

Upal Basu Roy, MPH, PhD — Executive Director of Research
LUNgevity Foundation

Sung Hee Choe, MPH — Senior Director
FasterCures (a center of the Milken Institute)

Hadly Clark, MHSA — Associate Director
FasterCures (a center of the Milken Institute)

John Hopper — Founding Co-Chair
National Organization for Rare Disorders (NORD) Rare Cancer Coalition

Marc Hurlbert, PhD — Chief Executive Officer
Melanoma Research Alliance

Christa Kerkorian — Vice President, Patient Advocacy
Day One Biopharmaceuticals

Mark W. Kieran, MD, PhD — Vice President, Clinical Development
Day One Biopharmaceuticals

E. Anders Kolb, MD* — Chief Executive Officer
Leukemia & Lymphoma Society

Stacie C. Lindsey — Founder and Chief Executive Officer
Cholangiocarcinoma Foundation

Donna Ludwinski — Director of Research Programs
Solving Kids' Cancer

Joe McDonough — President
The Andrew McDonough B+ (Be Positive) Foundation

Mitchell R. Smith, MD, PhD — Chief Medical Officer
Follicular Lymphoma Foundation

Kirk Tanner, PhD — Chief Scientific Officer
National Brain Tumor Society

Amy J. Weinstein — National Director of Research Investments
Pediatric Brain Tumor Foundation

Kelli Wright — Director, Patient Advocacy
Day One Biopharmaceuticals

*Dr. Kolb did not receive remuneration for his participation in the workshop.

Framework for Multistakeholder Collaboration

The outcome of the workshop was a co-created Framework for Multistakeholder Collaboration in Pediatric Cancer Research and Drug Development (Framework). The Framework that follows is based on both the exploration of the tovorafenib story and the collective experience of and best practices identified by workshop participants. It is organized around five critical components (see Figure 7).

FIGURE 7: Critical components.

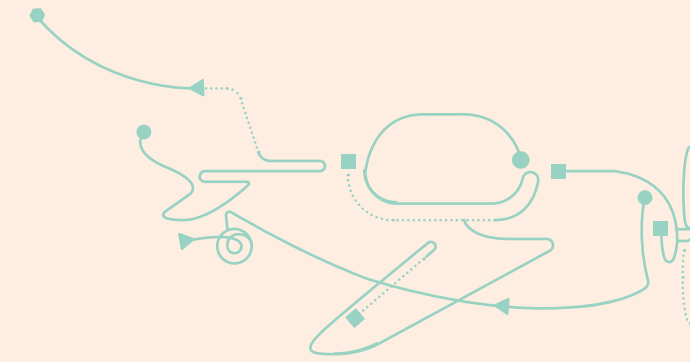

1. A core, multistakeholder group of individuals dedicated to a specific therapeutic area

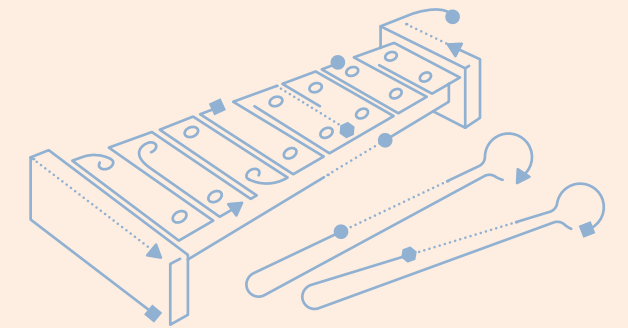

2. Strategic, long-term, sustained funding on a focused research program

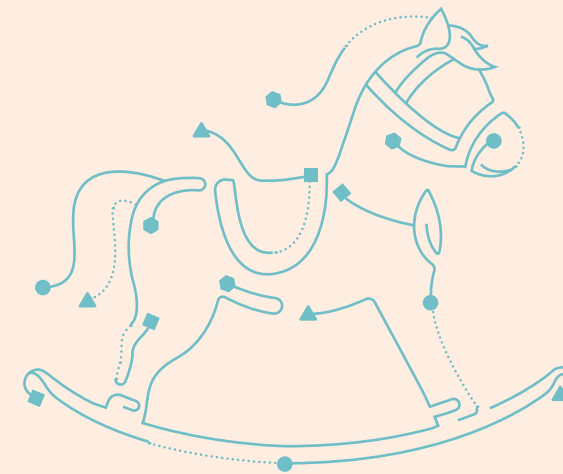

3. An industry champion committed to pediatric cancer

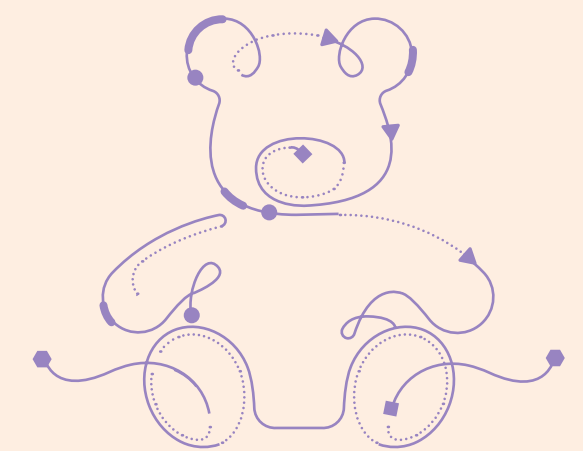

4. A multidisciplinary academic research program, including key stakeholders

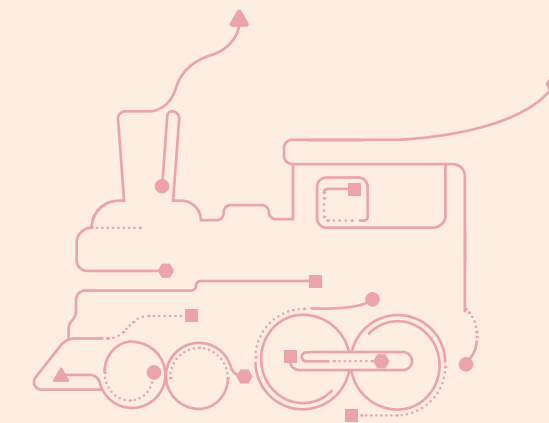

5. NPO involvement throughout the journey

Component 1: A Core, Multistakeholder Group of Individuals Dedicated to a Specific Therapeutic Area

In a successful collaboration, individuals bring their unique perspectives, expertise, and professional networks to a research program. Individuals who are equally committed to both the work and to the collaboration are critical to drive research progress over the long term (Table 1).

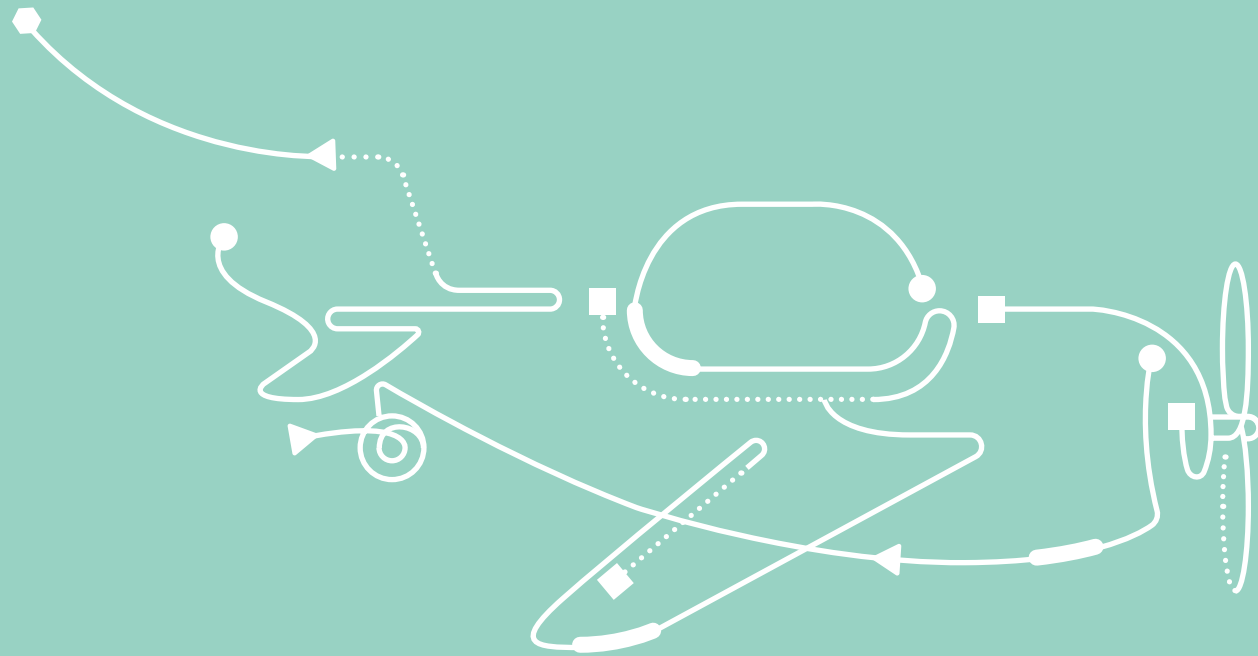

Characteristics

Diversity in Stakeholders

Participants with diverse perspectives and professional expertise across stakeholder groups.

Collaborative Spirit

A shared commitment to the therapeutic area's advancement and willingness to consider differing stakeholder perspectives.

Clear Vision and Objectives

Unwavering pursuit of clearly defined objectives.

Roles & Responsibilities

NPOs

■ Advocacy and Awareness

Raise awareness of unmet needs through storytelling; independently rally support for research funding, and advocate for change on multiple fronts.

■ Research Inspiration

Serve as inspiration of the research program, reinforcing urgent needs of patients and families; encourage continued commitment from the research institution.

■ Convener of Experts

Leverage extended networks to support the identification and forming of NPO SABs to guide research funding; convene experts beyond SABs to explore research concepts and advances in the therapeutic area.

Academia

● Research Field Advancement

Conduct research that contributes to understanding the disease; follow the science wherever it leads to move the research field forward.

● Research Champion

Champion the research program within the academic institution, raising awareness of its progress and advocating for essential resources and long-term funding.

● Talent Acquisition and Succession Planning

Recruit top talent to support program continuity and plan for attrition; provide support for young investigators, fostering the next generation of scientific leaders.

Industry

▲ Scientific Advisory Board Participation

Serve as advisors on NPO SABs, providing insights and expertise in drug development to inform research funding decisions.

▲ Regulatory Requirement Expertise

Advise on study designs to generate data necessary for potential filing with health authorities; advise the core group regarding regulatory requirements related to the research program.

▲ Innovative Business Models

Implement business models that support drug development for pediatric and other rare cancers.

Table 1: Core, multistakeholder group of individuals dedicated to a specific therapeutic area; characteristics, roles, and responsibilities.

Component 2: Strategic, Long-Term, Sustained Funding on a Focused Research Program

Pediatric cancer research and drug development is a long-term process that cannot be sustained by short-term, unpredictable funding infusions. Seed funding of novel concepts, often by NPOs, lays the foundation for promising research that, in turn, makes possible longer-term, more significant funding. Multiple income streams from diverse sources reduce reliance on a single funder or donor, and clear and open communication with all funders about short- and long-term research objectives and progress can help sustain a program's continued funding over time (Table 2).

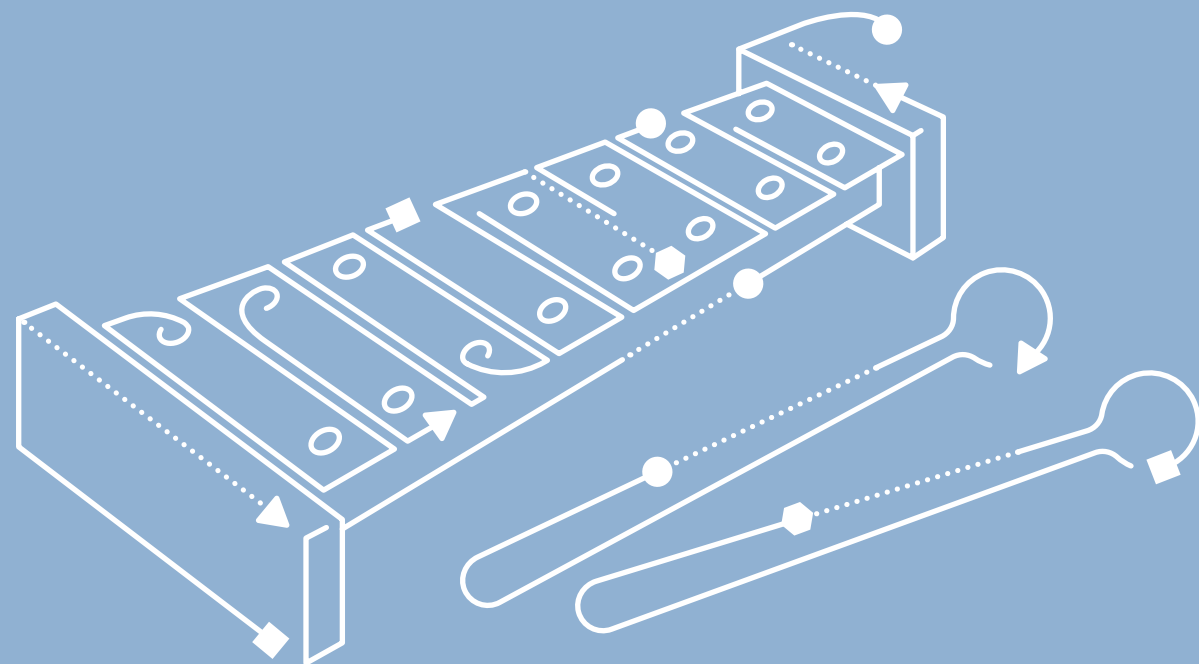

Characteristics

Multiple Funding Sources

A well-structured funding strategy encompassing substantial financial support from private, public, and government funders.

Risk Management and Expectations

Careful management of funder/donor expectations, aligning them with long- and short-term goals built upon well-informed understanding of financial risks associated with scientific research and clinical drug development.

Trust and Communication

Agreements with funders rooted in trust, supported by regular and transparent communication.

Roles & Responsibilities

NPOs

- **Research Funding**
Lead fundraising efforts for and commit to multi-year funding of the research program; identify unmet needs and funding gaps and invest resources accordingly.
- **Fundraising Ecosystem Expansion**
Network with other NPOs, patients and families, large private donors, and venture philanthropists to expand and diversify the network of financial support for the program.
- **Mission Development and Communication**
Articulate clear and compelling patient-focused mission and serve as ambassadors for the research program; passionately share the program's purpose to generate enthusiasm and sustained funding from an informed and engaged public. Report funding impact to NPO donors, volunteers, fundraisers.

Academia

- **Supplemental Funding**
Apply for and leverage federal grants and supplemental funding from philanthropic organizations and industry.
- **Infrastructure and Staffing**
Ensure that the necessary resources are in place to support the research program, including facilities, laboratories, qualified scientists and clinical research staff.
- **Data Sharing at Medical Congresses**
Attract attention of the broader scientific community and bolster the case for additional funding by showcasing the program's progress and sharing data at medical congresses.

Industry

- ▲ **Investigator-Sponsored Study Support**
Provide critical funding and/or in-kind drug or technology donation for academia-sponsored preclinical and clinical research, along with regulatory expertise to support potential drug development and health authority approval of new medicines.

Table 2: Strategic, long-term, sustained funding on a focused research program; characteristics, roles, and responsibilities.

Component 3: An Industry Champion Committed to Pediatric Cancer

Industry champions are individuals who are committed to pediatric cancer drug development within their organizations. They can navigate internal business dynamics, foresee challenges and barriers, and influence decision-makers to address obstacles strategically, before decisions are made that could negatively impact a compound's development. Beyond the individual, the company must also have the infrastructure and experience to bring a drug to market, the ongoing capital to support this process, and commitment to developing potential new therapies for pediatric cancer (Table 3).

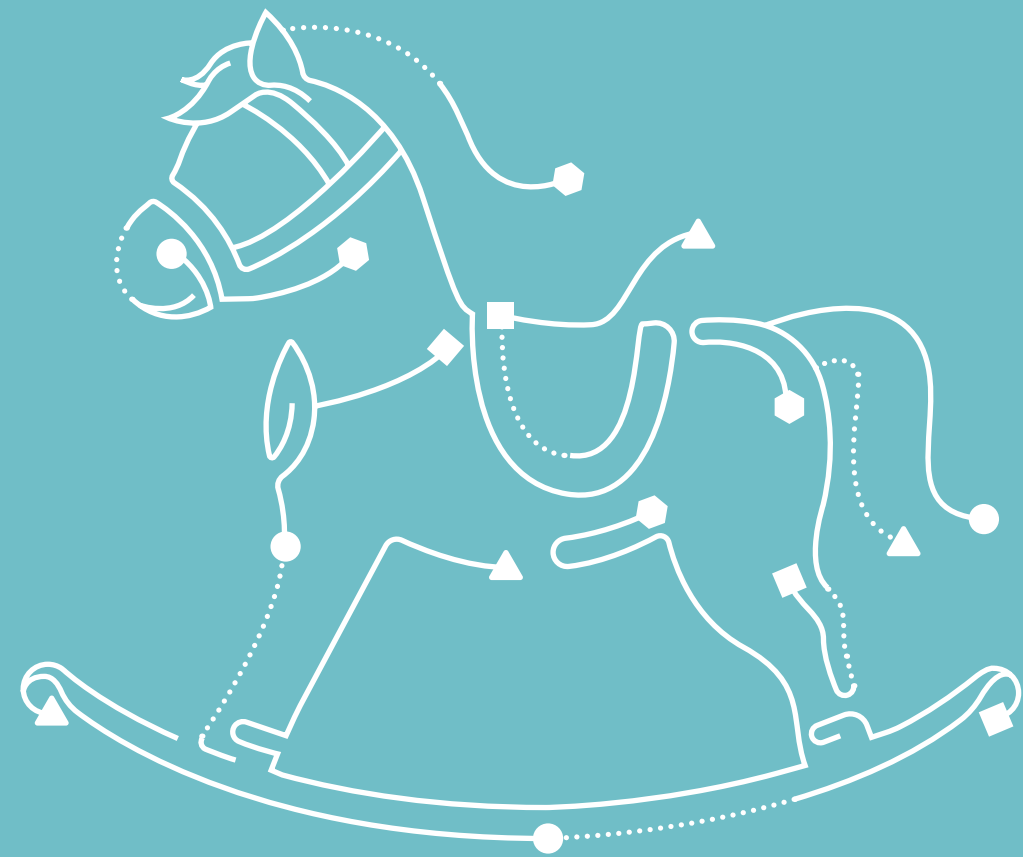

Characteristics

Passion and Commitment

Demonstrate authentic passion and steadfast commitment to influencing corporate priorities through strategic problem-solving and issues management.

Influence and Decision-Making

Individual champions must hold decision-making authority and/or possess the ability to influence key decision-makers within the company.

Corporate Infrastructure and Capability

Champion companies must have an institutional commitment to pediatric cancer drug development, along with the infrastructure and experience to move the program forward.

Roles & Responsibilities

NPOs

Industry Relationships

Identify and build strong relationships with industry counterparts, often starting with the industry patient advocacy function, to cultivate partnerships that drive progress.

Bridge Research Awareness Gaps

Bridge the gaps between academia and industry to raise awareness of promising and potentially at-risk research and opportunities for collaboration.

Seat at the Table

Secure a seat at the table with industry stakeholders to ensure that the patient voice is heard and informs industry decision-making throughout the drug development process.

Academia

Compelling Case for Collaboration

Build an evidence-based case for industry collaboration by demonstrating the research significance and the academic team's expertise and capabilities.

Inclusive Engagement

Invite NPOs to participate in relationship-building engagement with industry, creating opportunities for the patient perspective and NPO expertise to be factored into drug development considerations.

Collaborative Studies

Engage with industry early to confirm whether a supported clinical trial is being conducted with intent to file; if so, collaborate to ensure that the resulting data set will be fit for filing with regulatory authorities.

Industry

Internal Advocacy

Advocate within the organization for investment in research in the therapeutic area, and work to ensure that required financial and human resources are made available.

Leveraging Expertise

Apply drug development expertise to identify opportunities to accelerate or expand the research into other therapeutic areas.

Creative Problem Solving

Identify potential solutions when faced with competing or shifting corporate priorities.

Research and Development Infrastructure

Possess or acquire the required experience, infrastructure, and ongoing capital to take research from bench to bedside and bring new therapies to market.

Table 3: An industry champion committed to pediatric cancer; characteristics, roles, and responsibilities.

Component 4: A Multidisciplinary Academic Research Program, Including Key Stakeholders

Academic research programs are an essential catalyst for building a successful pediatric cancer research program and laying the foundation for longer-term efforts. A well-founded structure includes committed scientific and institutional leadership, investigators and project managers within the academic research environment who understand the importance of and are skilled at working collaboratively with stakeholders towards the long-term success of a program (Table 4).

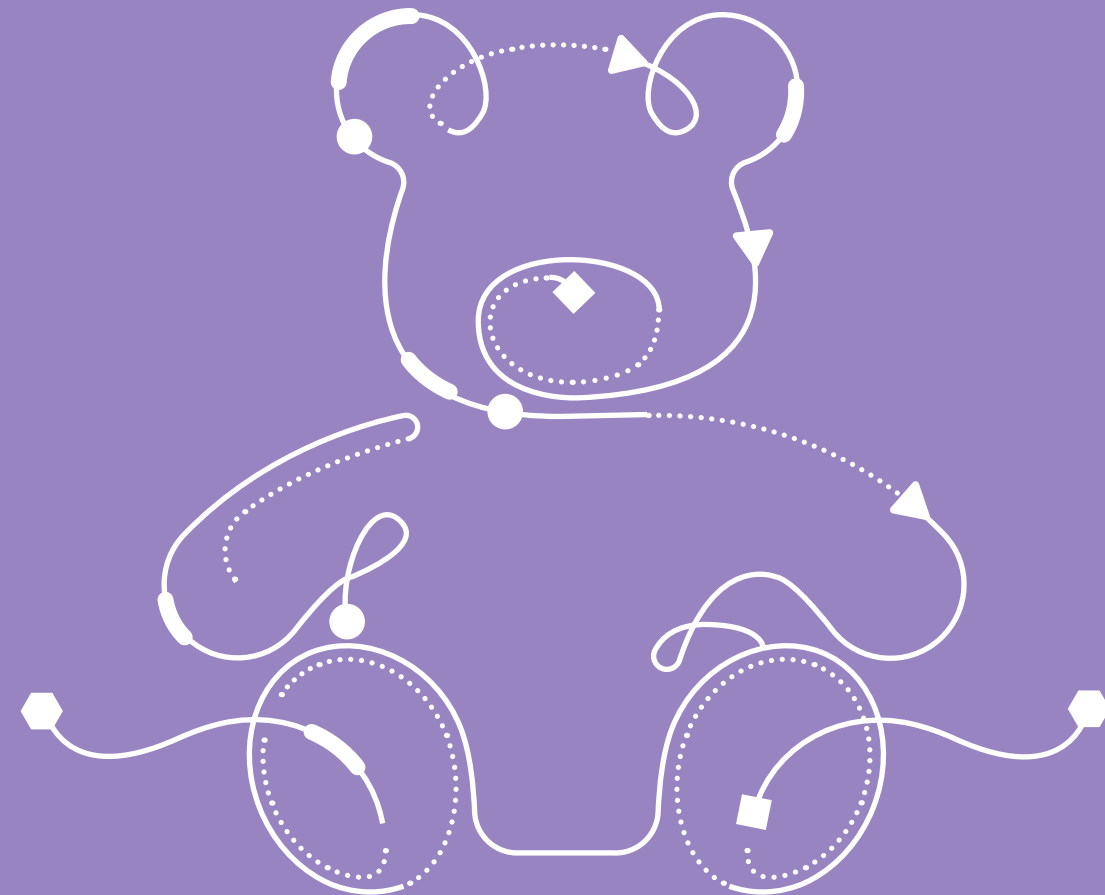

Characteristics

Institutional Support

Strong multidisciplinary programs are built upon steadfast support from the research institution's leadership, as well as the scientific and industry advisors.

Leadership and Governance

Effective program leadership and governance are supported by well-defined operational structures and robust project management and communications.

Goal Commitment and Mutual Respect

Team members share a commitment to the program's goals and respect each other's areas of expertise.

Roles & Responsibilities

NPOs

■ Mission and Patient Focus

Communicate and reinforce lived patient experiences and urgency of addressing unmet medical needs aligned with the research program.

■ Funding Distribution

Raise and distribute funds to the research program, per agreed-upon milestones and funding commitments.

Academia

● Research Program Advancement

Provide scientific, medical, and clinical expertise to support critical decisions in clinical trial design and investigator-initiated studies.

● Institutional Accountability and Risk Management

Manage and navigate institutional demands, expectations of research progress, and perception of risk; address program-related pressures and advocate for continued funding through risk assessments, data-driven decision-making, and transparent communications.

● Identify and Support Program Champion

Elevate internal champion to lead the program, secure required resources and continued institutional support, engage key inter-departmental teams, and support training of the next generation of scientific leaders.

Industry

▲ Study Design and Drug Development Expertise

Provide insights regarding fit-for-filing study design to support potential filing with regulatory agencies; provide insights regarding industry considerations for drug development, including target validation, paths to the clinic, and agent availability.

Table 4: A multidisciplinary academic research program, including key stakeholders; characteristics, roles, and responsibilities.

Component 5: NPO Involvement Throughout the Journey

Patients and families are at the heart of any pediatric cancer research effort. The NPOs that represent them are often established by families with a very personal mission to save or improve their or other children's lives. They bring firsthand insights about the patient and family experience of a particular type of cancer to the research team, raising awareness of their unmet needs, helping investigators gain support in the patient community, and advocating for support from potential funders and donors (Table 5).

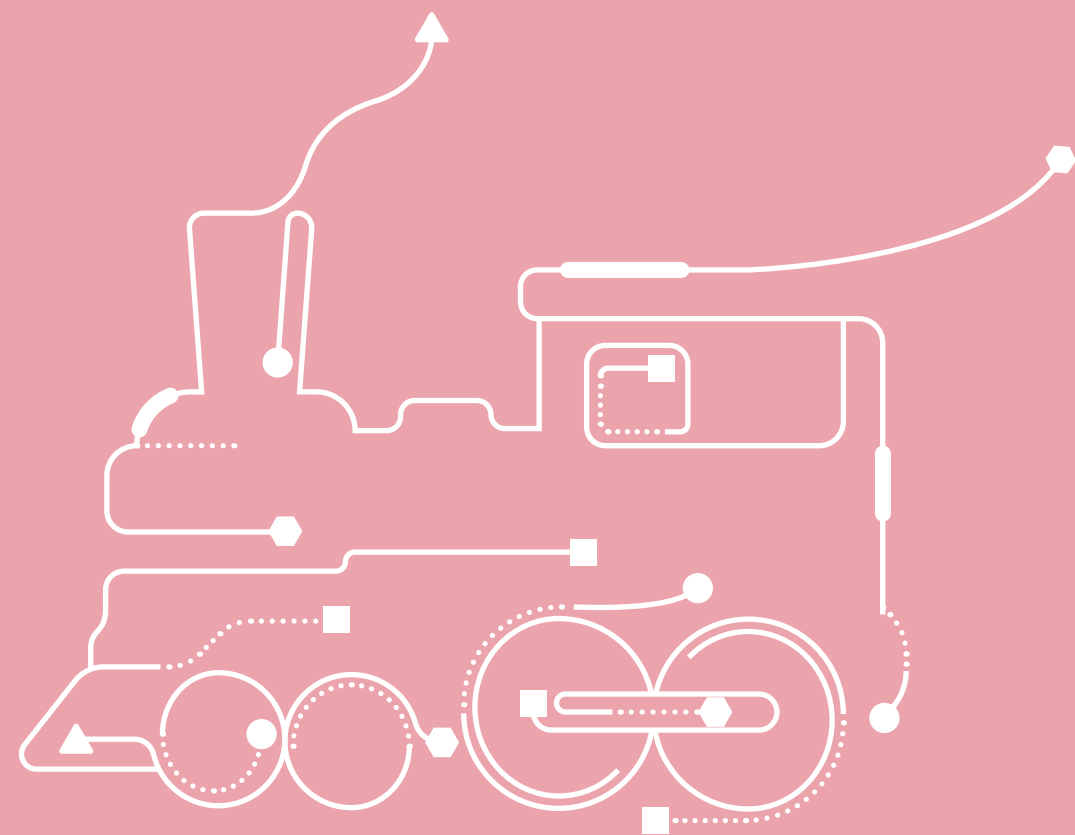

Characteristics

Mission-Driven Decision-Making

Early and continuous involvement of NPO(s) ensures decision-making is aligned with the mission and patient welfare and supports securement of additional funding, if required.

Thorough Disease and Therapeutic Landscape Knowledge

NPO representatives should possess and/or strive for comprehensive knowledge about the disease and therapeutic landscape, including past and present research efforts.

Collaborative Spirit

All stakeholders should demonstrate a willingness to collaborate and respect for each other's contributions and areas of expertise.

Roles & Responsibilities

NPOs

- **Engagement with Academia and Industry**
Engage with academia and industry early and often, reinforcing urgency of addressing unmet medical needs and ensuring alignment of shared objectives.
- **Relationship Building**
Cultivate long-term, trusting relationships aimed at achieving shared goals.
- **Landscape Knowledge**
Maintain knowledge of research advances, gaps, and unmet needs, as well as regulatory requirements.

Academia

- **Engagement with NPOs**
Engage with NPOs early and often to build trust, understand each other's capabilities, align communications, and support collaboration.
- **Communication and Reporting**
Communicate regularly with NPOs and adhere to agreed-upon reporting schedules regarding research progress, milestones reached, and other developments.
- **Research Awareness and Education**
Share research findings at NPO-sponsored patient conferences and community meetings; as much as possible, use patient-friendly language to communicate the science and to make the research more accessible to interested patients and families.

Industry

- ▲ **Engagement with NPOs**
Engage with NPOs early and often to build long-term, trusting relationships to advance shared goals for the patient community; ensure that the patient voice informs decision-making throughout the drug development process.
- ▲ **Collaboration on Protocols and Processes**
Foster robust dialogue with NPOs as integral partners to ensure the incorporation of the patient perspective into research protocols and at other key milestones in the drug development process, including regulatory interactions.

Table 5: NPO involvement throughout the journey; characteristics, roles, and responsibilities.

Conclusions

Through the lens of the tovorafenib journey, the power of collaboration is clear. In essence, collaboration is not just an option or a preference; it is fundamental to moving a pediatric cancer research program forward in a meaningful way.

As illustrated in this paper, the most effective collaborations are those in which key stakeholder groups are represented and their unique roles, perspectives, and expertise are valued and respected. Above all, these stakeholders share a commitment to improve the outlook for children with cancer and their families through research and drug development.

The Framework for Multistakeholder Collaboration in Pediatric Cancer Research and Drug Development is a tool to highlight the expertise and strengths of each stakeholder group and their working relationships with each other. While the Framework was developed specifically with pediatric cancer research and drug development in mind, it is designed to be flexible and adaptable to other non-pediatric rare cancers and diseases. Importantly, the complexity of any scientific research and drug development program cannot be overstated, and collaboration to advance scientific research and drug development is infinitely complex as well. The Framework is a first step in exploring effective multistakeholder collaboration.

In addition to examination of other case studies of effective multistakeholder collaboration, important topics for future exploration include:

- ◆ **Collaboration among international stakeholders** — NPOs, academia, and industry—for pediatric cancer research and drug development
- ◆ **Collaboration with US and international regulatory agencies** in drug development, particularly in the context of the “carrots” and “sticks” they apply
- ◆ **Collaboration with policymakers**, and how evolving public policy impacts stakeholder roles and responsibilities
- ◆ **Collaboration for improved access** to investigational therapies across the globe

Our hope is that this paper serves as inspiration for future discussions in pediatric cancer research and drug development that will further strengthen the field and, ultimately, benefit children with cancer, their families, and all who love them.

Appendix

ABOUT TOVORAFENIB CLINICAL TRIALS

Tovorafenib is an investigational, oral, type II RAF inhibitor being studied in:

- ◆ Pediatric patients with recurrent or progressive low-grade glioma and advanced solid tumors with RAF alterations (FIREFLY-1)⁴³
- ◆ Pediatric patients with RAF-altered low-grade glioma requiring front-line systemic therapy, versus standard of care chemotherapy (FIREFLY-2)⁴⁸
- ◆ Adolescent and adult patients with recurrent or progressive solid tumors with MAPK pathway alterations (FIRELIGHT-1)⁴⁹

ABOUT DAY ONE BIOPHARMACEUTICALS

Day One Biopharmaceuticals is a biopharmaceutical company focused on developing targeted therapies for pediatric cancer. Day One was founded to address a critical unmet need: the dire lack of therapeutic development in pediatric cancer. The Company’s name was inspired by “The Day One Talk” that physicians have with patients and their families about an initial cancer diagnosis and treatment plan. Day One aims to re-envision cancer drug development and redefine what’s possible for all people living with cancer—regardless of age—starting from Day One.

Day One partners with leading clinical oncologists, patient non-profit organizations, and scientists to identify, acquire, and develop important emerging cancer treatments. The Company’s pipeline includes tovorafenib and pimasertib. Day One is based in Brisbane, California.

References

- 1 Goldstick JE, et al. *N Engl J Med*. 2022;386(20):1955-1956.
- 2 Siegel RL, et al. *CA Cancer J Clin*. 2024;74:12-49.
- 3 Zettler ME. *EJC Pediatric Oncology*. 2023;1:100005.
- 4 Neel DV, et al. *Eur J Cancer*. 2019;112:49-56.
- 5 Spadoni C. *Curr Ther Res Clin Exp*. 2019;90:119–122.
- 6 Pharmaceutical Commerce. *Pediatric Medicine: Challenges Abound*. Published March 31, 2023. Accessed February 05, 2024. <https://www.pharmaceuticalcommerce.com/view/pediatric-medicine-challenges-abound>.
- 7 De Wilde B, et al. *J Clin Oncol*. 2022;40(29):3456-3464.
- 8 National Cancer Institute. *Making Transformative Advances against Childhood Cancer: A Conversation with Dr. Doug Hawkins*. Published September 28, 2022. Accessed February 02, 2024. <https://www.cancer.gov/news-events/cancer-currents-blog/2022/childhood-cancer-research-advances-cog-hawkins>.
- 9 Bo L, et al. *Cancers (Basel)*. 2023;15(7):1963.
- 10 Hudson MM, et al. *JAMA*. 2013;309(22):2371-81.
- 11 American Cancer Society. *Cancer Facts & Figures 2024*. Accessed February 05, 2024. <https://www.cancer.org/content/dam/cancer-org/research/cancer-facts-and-statistics/annual-cancer-facts-and-figures/2024/2024-cancer-facts-and-figures-acf.pdf>.
- 12 American Cancer Society. *After Treatment for Childhood Cancer*. Updated October 14, 2019. Accessed February 05, 2024. <https://www.cancer.org/cancer/types/cancer-in-children/late-effects.html>.
- 13 Lewandowska A. *Children (Basel)*. 2022;9(2):144.
- 14 Alderfer MA, et al. *Psychooncology*. 2010;19(8):789-805.
- 15 Huang C, et al. *JAMA Netw Open*. 2024;7(1):e2350814.
- 16 Warner EL, et al. *J Oncol Pract*. 2015;11(1):12-8.
- 17 Ohlsen T, et al. *Cancer*. 2023;doi:10.1002/cncr.35150.
- 18 National Pediatric Cancer Foundation. *About NPCF*. Accessed February 05, 2024. <https://nationalpcf.org/about-us/>.
- 19 American Childhood Cancer Organization. *About ACCO*. Accessed February 05, 2024. <https://www.acco.org/about/>.
- 20 Congress.gov. *Pediatric Research Equity Act of 2003*. Accessed February 05, 2024. <https://www.congress.gov/108/plaws/publ155/PLAW-108publ155.pdf>.
- 21 US Government Accountability Office. *Pediatric Cancer Studies: Early Results of the Research to Accelerate Cures and Equity for Children Act*. Published January 31, 2023. Accessed February 05, 2024. <https://www.gao.gov/products/gao-23-105947>.
- 22 National Institute of Child Health and Human Development. *Best Pharmaceuticals for Children Act*. Accessed February 05, 2024. <https://www.nichd.nih.gov/research/supported/bpca/about>.
- 23 US Food and Drug Administration. *Rare Pediatric Disease (RPD) Designation and Voucher Programs*. Accessed February 05, 2024. <https://www.fda.gov/industry/medical-products-rare-diseases-and-conditions/rare-pediatric-disease-rpd-designation-and-voucher-programs>.
- 24 ACCELERATE. *Research and Working Groups*. Accessed February 05, 2024. <https://www.accelerate-platform.org/research>.
- 25 Pearson ADJ, et al. *J Natl Cancer Inst*. 2023:djad239.
- 26 Allaway R, et al. *PLoS One*. 2018;13(6):e0197350.
- 27 FDA. *FDA approves selumetinib for neurofibromatosis type 1 with symptomatic, inoperable plexiform neurofibromas*. Accessed February 05, 2024. <https://www.fda.gov/drugs/resources-information-approved-drugs/fda-approves-selumetinib-neurofibromatosis-type-1-symptomatic-inoperable-plexiform-neurofibromas>.
- 28 EU-PEARL. *Platform trials in neurofibromatosis*. Accessed February 06, 2024. <https://eu-pearl.eu/case-studies/nf/>.
- 29 Redell MS, et al. *Blood*. 2023;142(Suppl 1):1492.
- 30 Milken Institute. *Nonprofits: A growing force in drug development*. Accessed February 05, 2024. https://milkeninstitute.org/sites/default/files/reports-pdf/NPDD-Final_0.pdf.
- 31 National Cancer Institute. *Specialized Programs of Research Excellence (SPORE)*. Accessed February 05, 2024. <https://www.cancer.gov/about-nci/budget/fact-book/extramural-programs/spores>.
- 32 Traunwieser T, et al. *Neurooncol Adv*. 2020;2(1):vdaa094.
- 33 Farwell JR, et al. *Cancer*. 1977;40(6):3123–32.
- 34 Ostrom QT, et al. *Neuro Oncol*. 2015;16 Suppl 10:x1-x36.
- 35 Bandopadhyay P, et al. *Pediatr Blood Cancer*. 2014;61(7):1173-9.
- 36 Krishnatry R, et al. *Cancer*. 2016;122(8):1261-9.
- 37 Armstrong GT, et al. *J Natl Cancer Inst*. 2009;101(13):946-58.
- 38 Broad Institute. *In search of a telltale sign*. Accessed February 05, 2024. <https://www.broadinstitute.org/blog/search-telltale-sign>.
- 39 Lindsay HB, et al. *Pediatr. Hematol. Oncol. J*. 2023;8(2):97-101.
- 40 Sun Y, et al. *Neuro Oncol*. 2017;19(6):774-785.
- 41 ClinicalTrials.gov. *DAY101 In Gliomas and Other Tumors*. ClinicalTrials.gov identifier NCT03429803. <https://classic.clinicaltrials.gov/ct2/show/NCT03429803>.
- 42 Day One Biopharmaceuticals. *Targeted Therapies for Patients of All Ages*. Accessed February 05, 2024. <https://www.dayonebio.com/>.
- 43 ClinicalTrials.gov. *A Study to Evaluate DAY101 in Pediatric and Young Adult Patients with Relapsed or Progressive Low-Grade Glioma and Advance Solid Tumors (FIREFLY-1)*. ClinicalTrials.gov identifier NCT04775485. <https://classic.clinicaltrials.gov/ct2/show/record/NCT04775485>.
- 44 Day One Biopharmaceuticals. *Day One's OJEMDA™ (tovorafenib) Receives US FDA Accelerated Approval for Relapsed or Refractory BRAF-altered Pediatric Low-Grade Glioma (pLGG), the Most Common Form of Childhood Brain Tumor*. Accessed April 24, 2024. <https://ir.dayonebio.com/news-releases/news-release-details/day-ones-ojem-datm-tovorafenib-receives-us-fda-accelerated>.
- 45 Milken Institute. Accessed February 05, 2024. <https://milkeninstitute.org/about>.
- 46 Solving Kids' Cancer. Accessed February 05, 2024. <https://www.solvingkidscancer.org.uk/>.
- 47 Colab Health. Accessed February 05, 2024. <https://www.colabhealth.co/>.
- 48 ClinicalTrials.gov. *DAY101 vs. Standard of Care Chemotherapy in Pediatric Patients With Low-Grade Glioma Requiring First-Line Systemic Therapy (LOGGIC/FIREFLY-2)*. ClinicalTrials.gov identifier NCT05566795. <https://classic.clinicaltrials.gov/ct2/show/results/NCT05566795>.
- 49 ClinicalTrials.gov. *Tovorafenib (DAY101) Monotherapy or in Combination With Other Therapies for Patients With Melanoma and Other Solid Tumors*. ClinicalTrials.gov identifier NCT04985604. <https://classic.clinicaltrials.gov/ct2/show/NCT04985604>.

